

# TEMPSHIELD ASSEMBLY INSTRUCTIONS

## FORD TRANSIT 130" WB CARGO LOW ROOF

This document presents the detailed procedures for assembling Legend Fleet components and accessories.

Customers can make use these step-by-step procedures and easily assemble without major difficulty.



519 688 1043  
[customercare@legendfleet.com](mailto:customercare@legendfleet.com)

56957 HWY 3 WEST,  
TILLSONBURG,  
ON N4G 4G8.

# Table of Contents

Walls .....	3
Ceiling .....	6
Doors .....	7

# Walls

## Parts List - Driver Side Wall

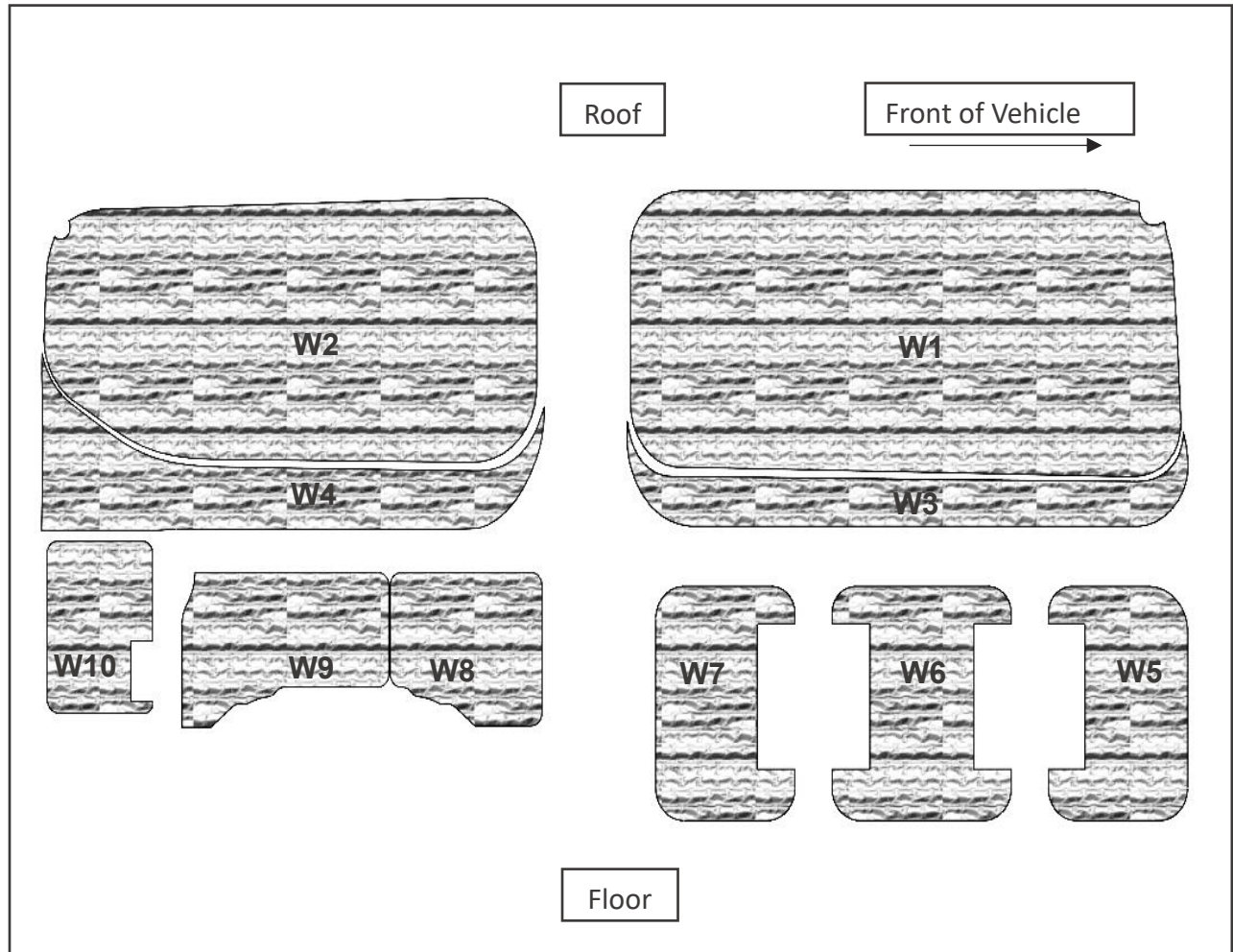

# Parts List - Passenger Side Wall

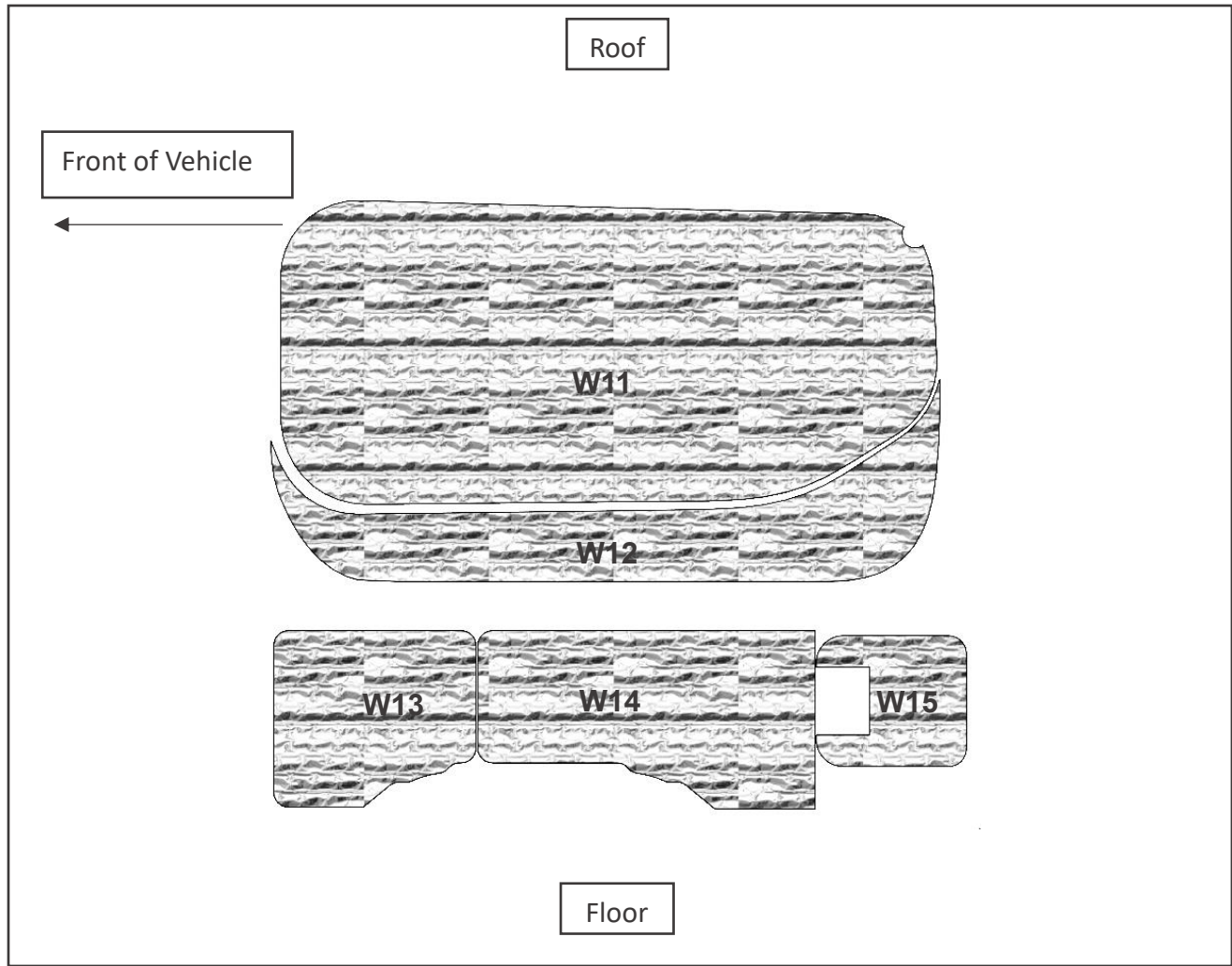

## Assembly Instructions

**Step 1:** Identify the TempShield Panels and their respective vehicle surfaces as shown below. For additional guidance, please refer to the sheet layouts found in the last two pages of this document.

**Step 2:** Wipe the identified surfaces of the vehicle clean, dry, free of dust, debris, or any foreign materials before adhering the TempShield panels.

**Step 3:** Peel off the protective layer of the TempShield and place its adhesive side to the Van body. **NOTE** – you may leave the protective layer on for pocketed areas such as W8 and W13.

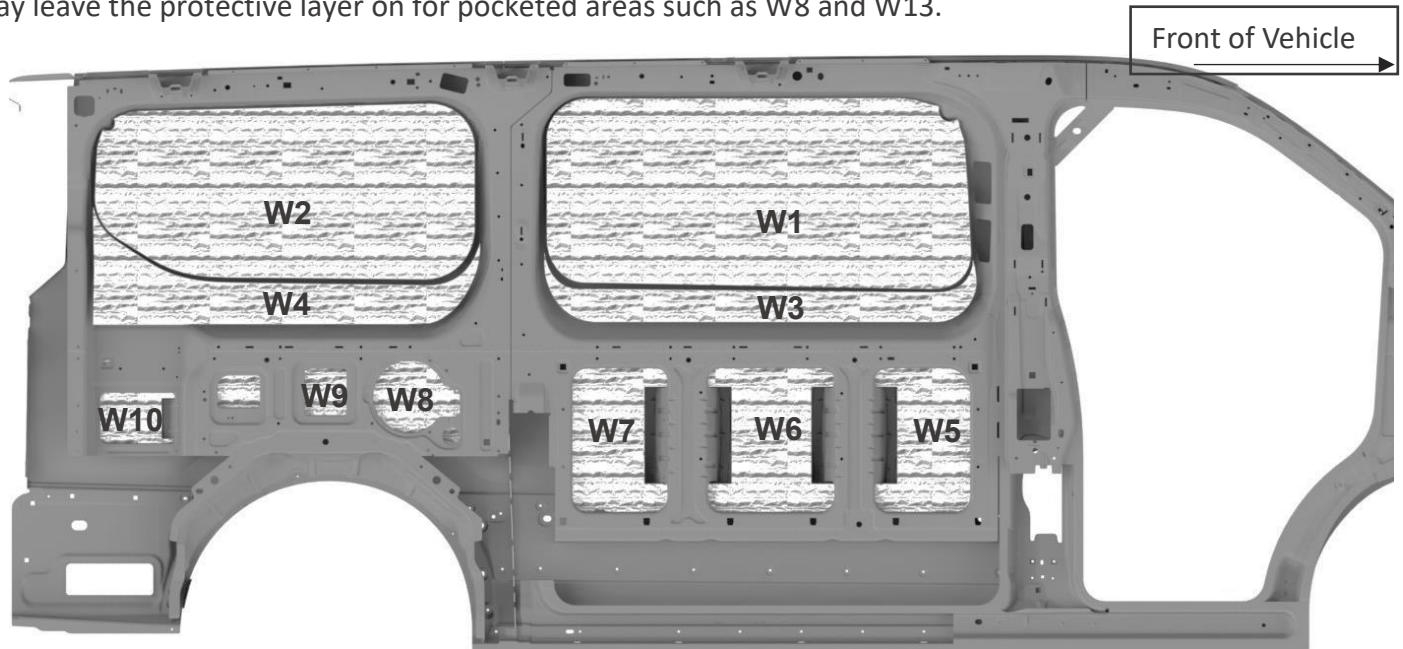

Figure 1

*"Driver side TempShield Installed" This view is from Inside of Van-Viewing from Passenger side*

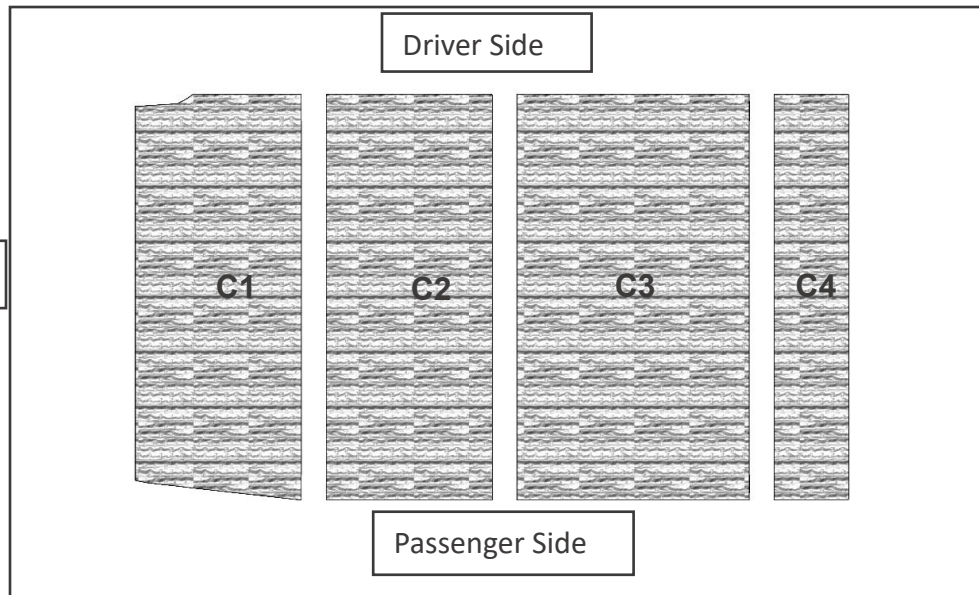

Figure 2

*"Passenger side TempShield Installed" This view is from Inside of Van-Viewing from Driver side*

# Ceiling

## Parts List



## Assembly Instructions

**Step 1:** Identify the TempShield Panels and their respective vehicle surfaces as shown below. For additional guidance, please refer to the sheet layouts found in the last two pages of this document.

**Step 2:** Wipe the identified surfaces of the vehicle clean, dry, free of dust, debris, or any foreign materials before adhering the TempShield panels.

**Step 3:** Peel off the protective layer of the TempShield and place its adhesive side to the Van body.

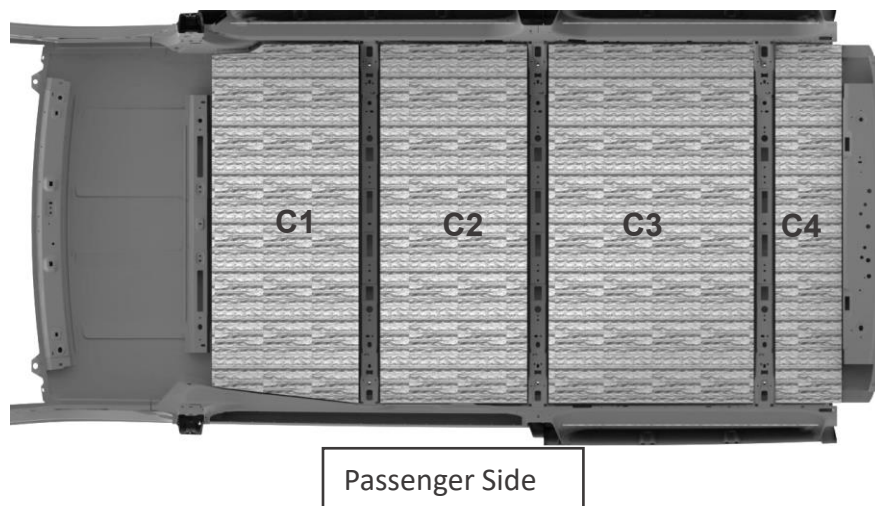
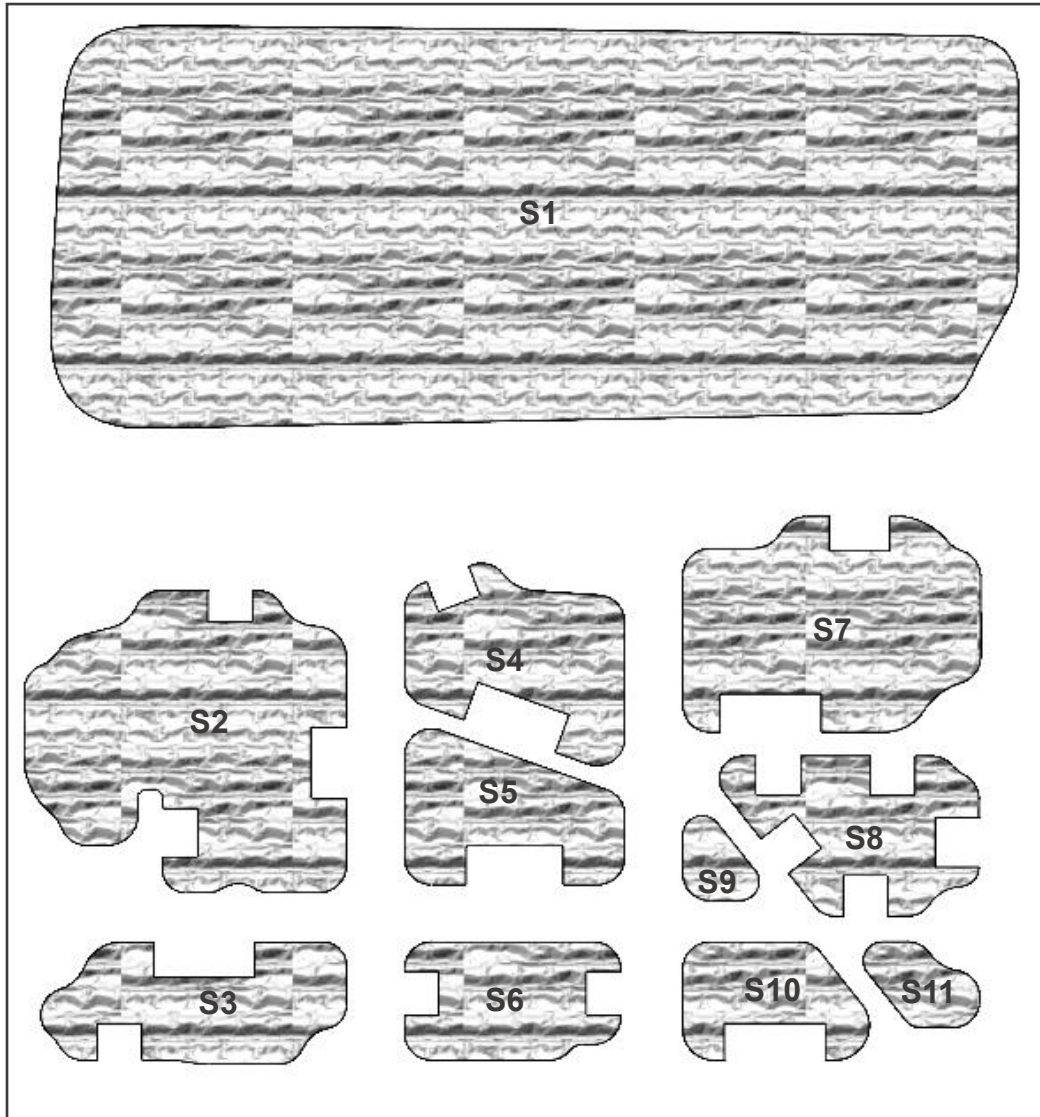

Figure 3

*"Ceiling TempShield Installed" This view is from Inside of Van*

# Doors

## Parts List – Sliding Door



Passenger Side Sliding Door TempShield

# Parts List – Rear Door

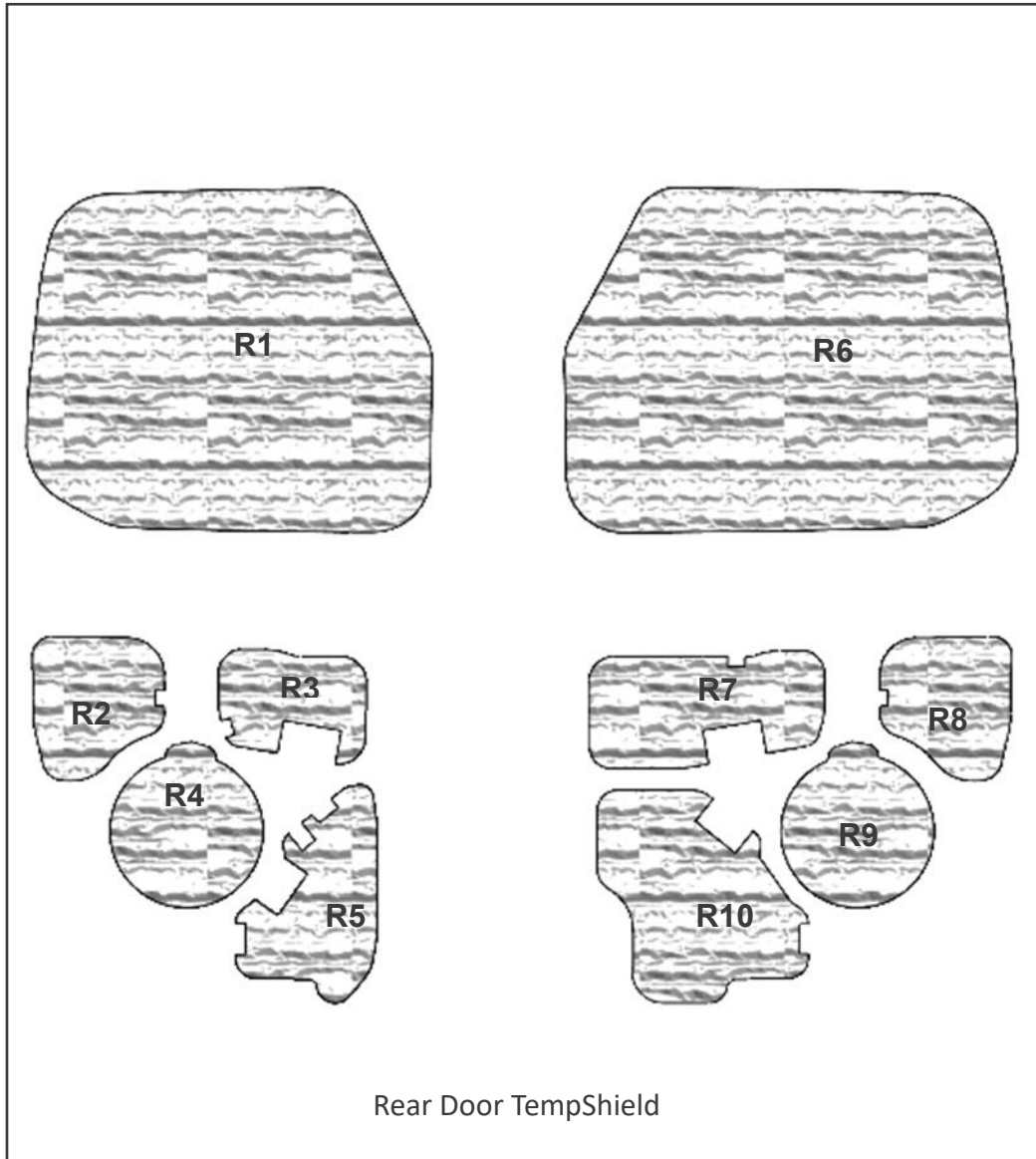



## Assembly Instructions

**Step 1:** Identify the TempShield Panels and their respective vehicle surfaces as shown below. For additional guidance, please refer to the sheet layouts found in the last two pages of this document.

**Step 2:** Wipe the identified surfaces of the vehicle clean, dry, free of dust, debris, or any foreign materials before adhering the TempShield panels.

**Step 3:** Peel off the protective layer of the TempShield and place its adhesive side to the Van body.

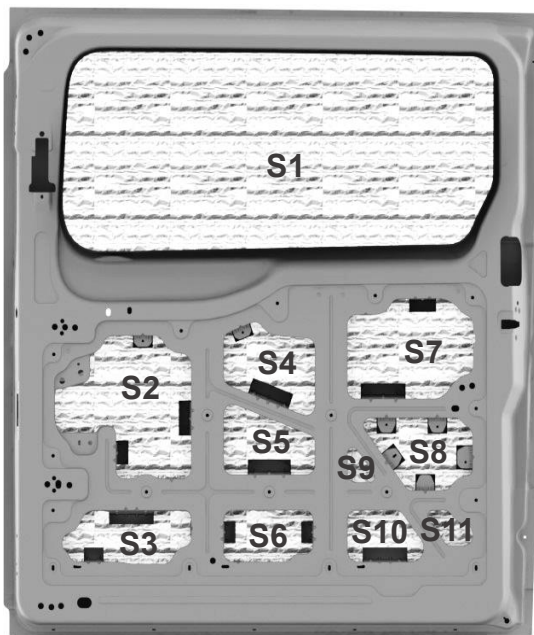

Passenger Side Sliding Door TempShield

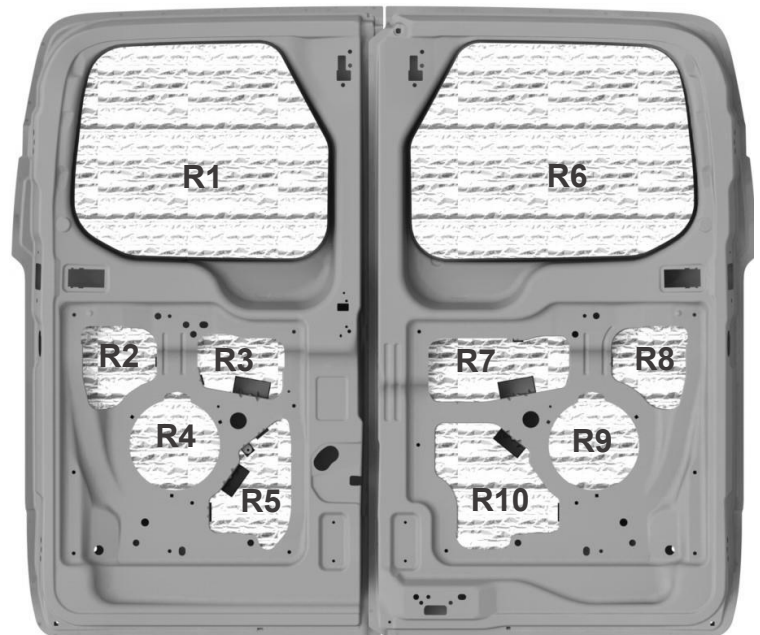

Rear Door TempShield

# Sheet Layouts

